

FAG

QJ206-XL-MPA

Four-point contact bearing

Schaeffler ID:
0167422220000Four point contact bearing QJ2..-XL-MPA,
X-life, solid brass cage

X-life

Technical information

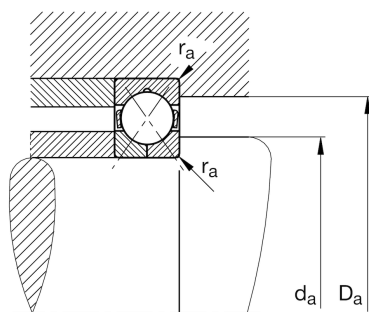
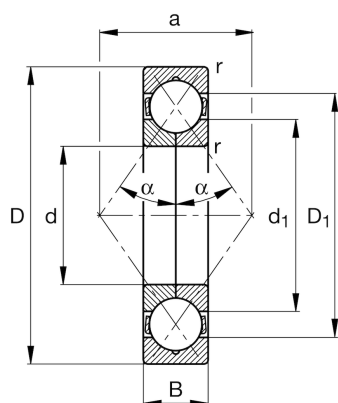

Main Dimensions & Performance Data

d	30 mm	Bore diameter
D	62 mm	Outside diameter
B	16 mm	Width
C_r	37,500 N	Basic dynamic load rating, radial
C_{0r}	27,500 N	Basic static load rating, radial
C_{ur}	1,930 N	Fatigue load limit, radial
n_G	23,200 1/min	Limiting speed
n_{gr}	10,200 1/min	Reference speed
	0.24 kg	Weight

Dimensions

r_{min}	1 mm	Minimum chamfer dimension
D_1	50.7 mm	Shoulder diameter outer ring
d_1	40.4 mm	Shoulder diameter inner ring
a	32 mm	Distance between the apexes of the pressure cones
α	35 °	Contact angle

Mounting dimensions

$d_{a min}$	36 mm	Minimum diameter shaft shoulder
$D_{a max}$	56 mm	Maximum diameter of housing shoulder
$r_{a max}$	1 mm	Maximum fillet radius

Temperature range

T_{min}	-30 °C	Operating temperature min.
T_{max}	150 °C	Operating temperature max.